

Data Sheet



Article number: 03491030

Description: Fluro Heavy Duty Rod end EA 30 EW-2RS
M30x2 Male thread

Note: 30

Measures

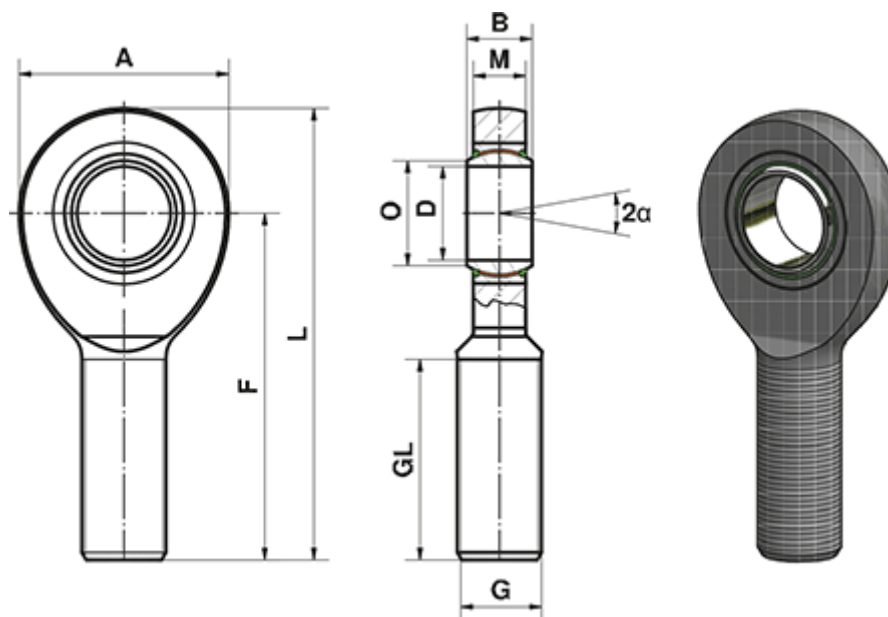

A	= 73	L	= 146.5
a (degrees)	= 6	M	= 18
B	= 22	O	= 34.2
D	= 30	Static load C0 (kN)	= 124
Dynamic load C (kN)	= 165	Weight (g)	= 890
F	= 110		
G	= M30x2		
GL	= 65		